

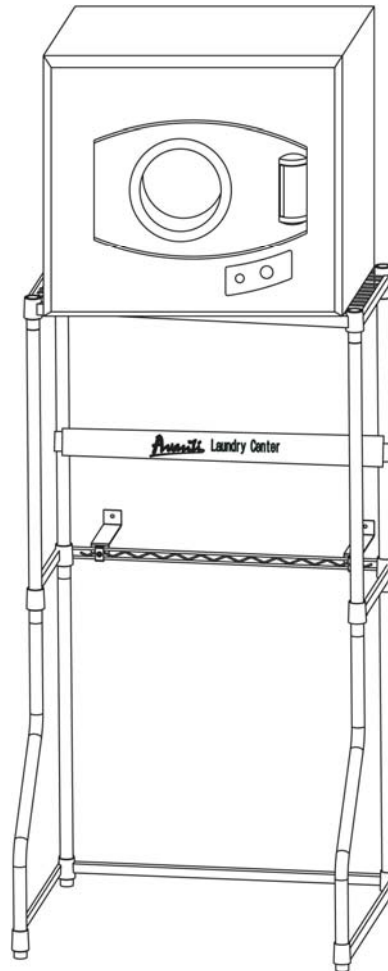

**INSTRUCTION MANUAL
MANUAL DE INSTRUCCIONES**

Model Number/ No. de Modelo: WDB101

CLOTHES DRYER STACKING BRACKET



**CAUTION:
BEFORE USE, PLEASE READ AND FOLLOW ALL SAFETY RULES AND OPERATING
INSTRUCTIONS.**

Avanti has a policy of continuous improvement on its products and reserves the right to change materials and specifications without notice.

**Avanti Products
P.O. Box 520604 - Miami, Florida 33152
www.avantiproducts.com**

Before beginning to assemble this product, review and ensure that you have received all of the parts as listed / shown below:

Components Included		
Part Code:	Description	Quantity
A	Bottom Support Frame	1
B	Middle Support Frame	1
C	Top Shelf	1
D	Rear Leg (Bottom section)	2
E	Front / Rear Leg (Top section)	4
F	Front Leg (Bottom section)	2
G	Anti-Tip Safety Bracket (Part 1 of 2)	2
H	Anti-Tip Safety Bracket (Part 2 of 2)	2
I	Shelf / Frame Support Clips	30**
J	Spanner Wrench	1
K	Nut (For Anti-Tip Safety Bracket Assembly)	2
L	Wall Anchor	2
M	Phillips Head Self-Tapping Screw	2
N	Phillips Head Metal Screw (For Anti-Tip Safety Bracket Assembly)	2
O	Logo / Support Bar	1
P	Front / Rear Leg (Middle section)	4
Q	Plastic Pad (Not for installation. For packing protection only)	4

**** Part I: 2 additional pieces are supplied as spares.**

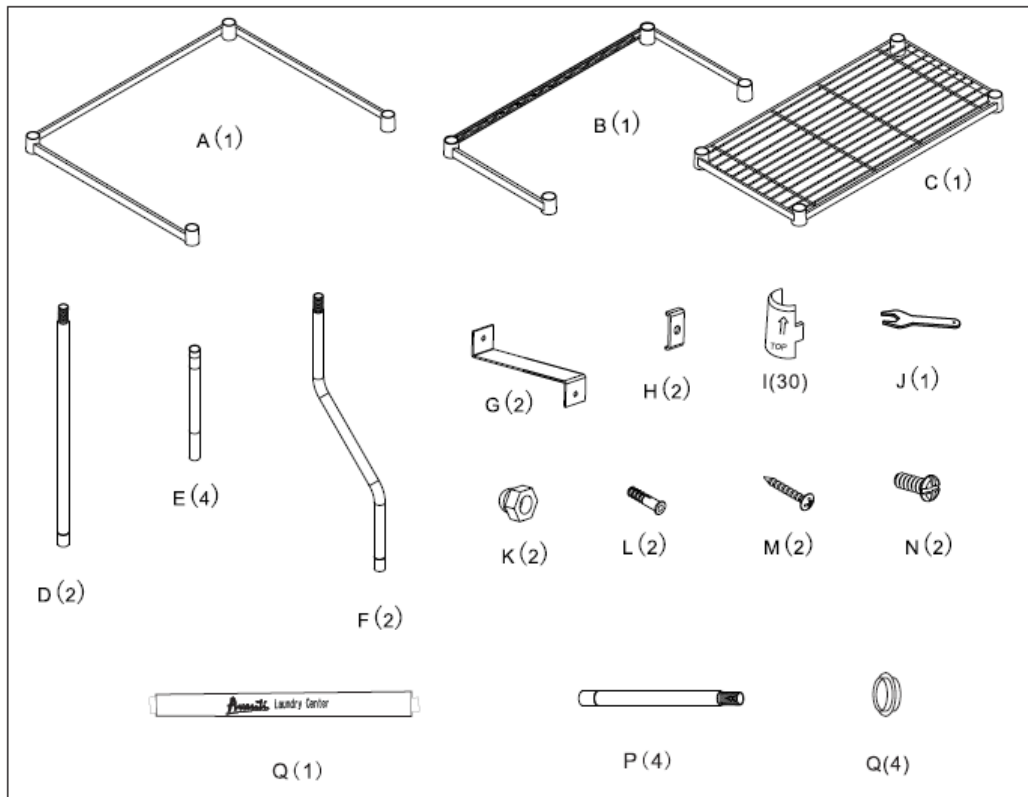

Assembled Dimensions

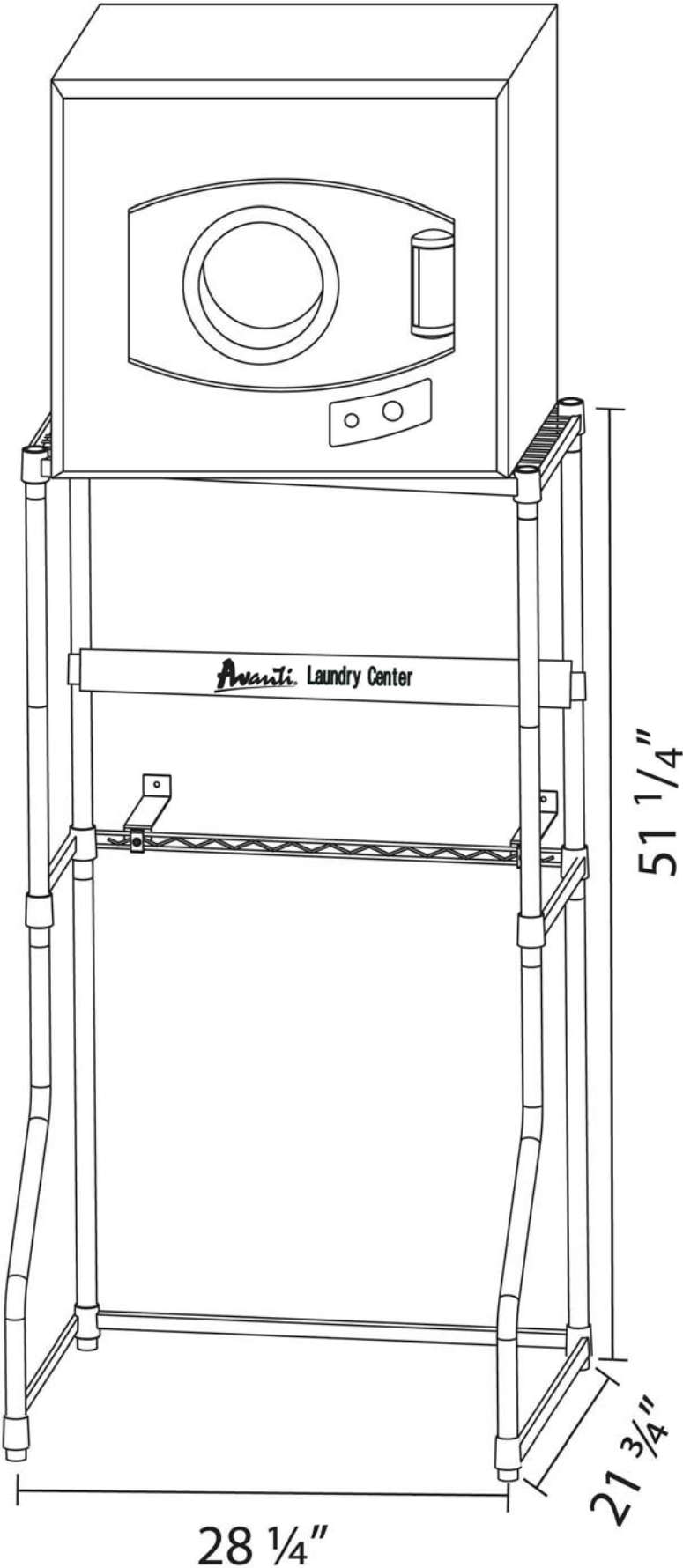

Your Washer / Dryer Stacking Bracket is designed to accommodate both top loading or front loading washing machines. Follow the assembly instructions below to assemble the bracket to fit your specific washing machine type. Images shown in this instruction guide are for assembly for use with a TOP-Load washer.

Step 1: Assembling the legs:

When using with a TOP- Load washer.

- Assemble the rear legs by screwing together all three sections of the rear leg.
 - Part D – Rear Leg (Bottom section)
 - Part P – Front / Rear Leg (Middle section)
 - Part E – Front / Rear Leg (Top section)
- Assemble the front legs by screwing together all three sections of the front leg.
 - Part F – Front Leg (Bottom section)
 - Part P – Front / Rear Leg (Middle section)
 - Part E – Front / Rear Leg (Top section)

When using with a FRONT-Load washer.

Assemble the rear legs by screwing together only the bottom and top sections of the rear leg (Parts D & E).

Assemble the front legs by screwing together only the bottom and top sections of the front leg (Parts F & E).

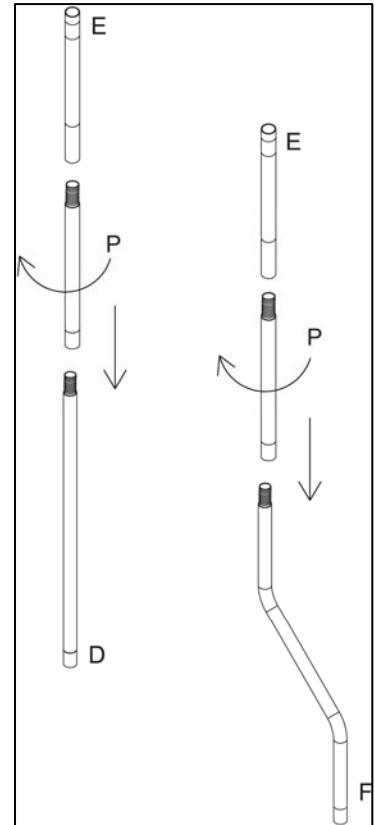

Step 2: Assembling the Bottom Support Frame.

We suggest that you put the U shaped bottom support frame (Part A) in a vertical position. As this will allow you to insert the legs and the Shelf / Frame support clips with ease.

- a) Lay the Bottom support frame (Part A) on its back with each side bar facing upwards.
- b) Insert each of the rear legs (assembled in step one) into the holes at both rear corners of the support frame.
- c) Using the Shelf / Frame support clips (Part I) insert the plastic tapered clips into the appropriate grooves on each leg. (See the image).
- d) Slightly press the bottom support frame downward on to the support clips.
- e) Insert each of the FRONT legs in the remaining corner holes of the support frame and repeat Step C.
- f) Stand the unit upright to continue the remainder of this assembly.
- g) Press each corner downward firmly to ensure the support frame is fully locked into position.

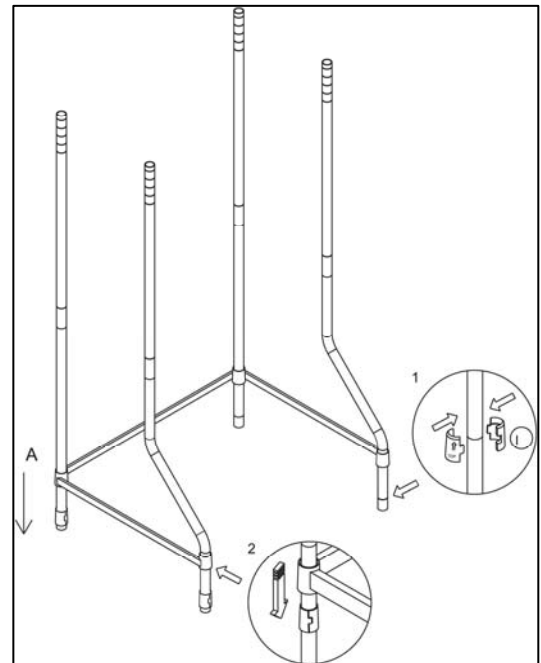

Step 3: Assembling the Middle Support Frame and Logo / Support Bar.

The Middle support frame (Part B) MUST be installed to maintain the stacking bracket square and stable.

- a) Using the Shelf / Frame support clips (Part I) insert the plastic tapered clips into the appropriate grooves on each leg. (See the image).
- b) Align the corner holes of the Middle support frame (Part B) with each of the legs and gently lower onto the support clips. Press each corner downward firmly to ensure the support frame is fully locked into position.
- c) Using the Shelf / Frame support clips (Part I) insert the plastic tapered clips into the appropriate grooves on each of the rear legs. (See the image).
- d) Align the holes on each end of the LOGO / Support Bar (Part O) with each of the rear legs and slightly lower onto the support clips.

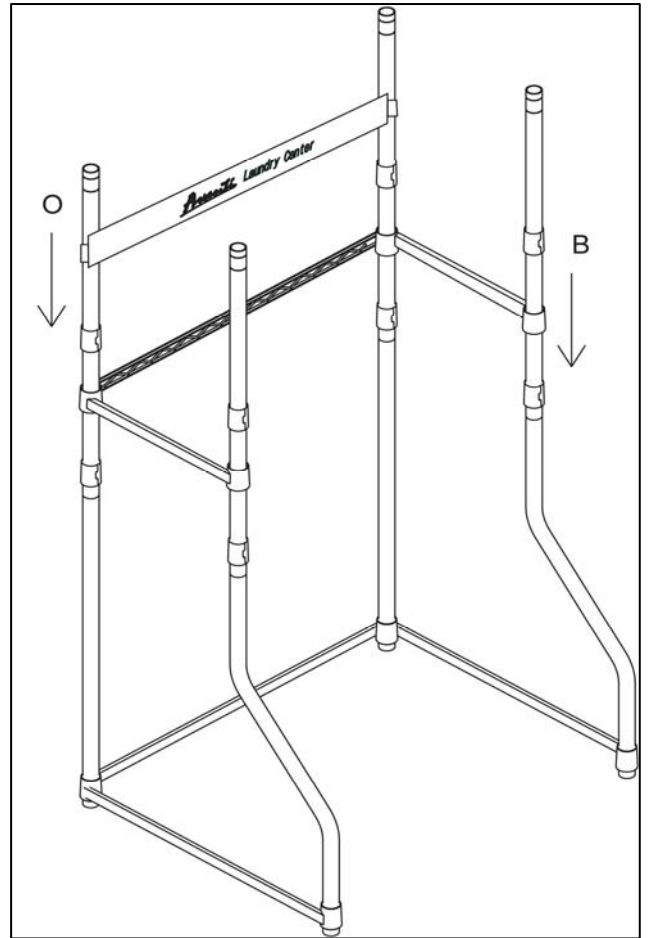

Step 4: Assembling the Top Shelf:

- a) Using the Shelf / Frame support clips (Part I) insert the plastic tapered clips into the appropriate grooves on each of the rear legs. (See the image).
- b) Align the holes at each corner of the Top Shelf (Part C) with each of the legs and gently lower onto the support clips.

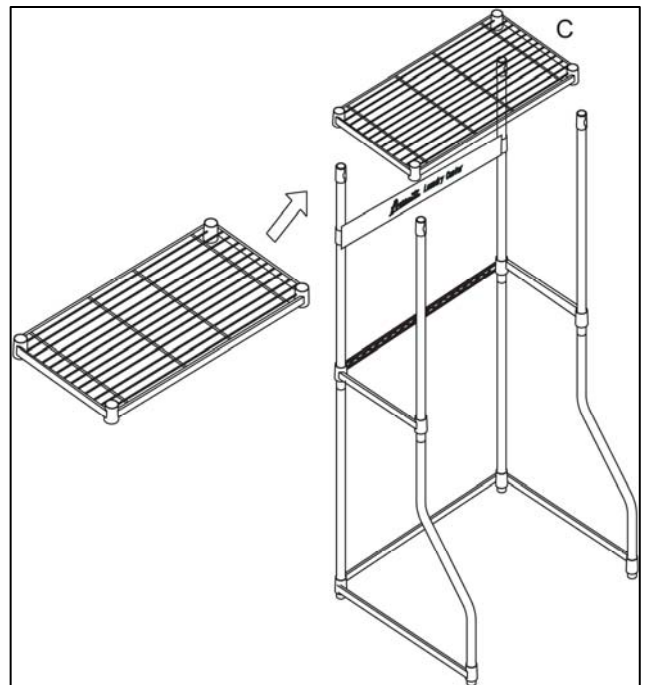

Step 5: Installing the Anti-Tip Safety Bracket:

- a) Attach the Anti-Tip Safety Bracket (Parts G and H) to the Stacking bracket as shown. By joining the two (2) parts using the Phillips Head Screw and Nut (Parts K and N).
- b) Align the assembled Stacking bracket in place and mark where the Anti-Tip Safety Bracket is to be attached to the wall.
- c) Using the Wall Anchors and Self Tapping Phillips head screws (Parts L and M) included to attach the assembled Stacking bracket to the wall.

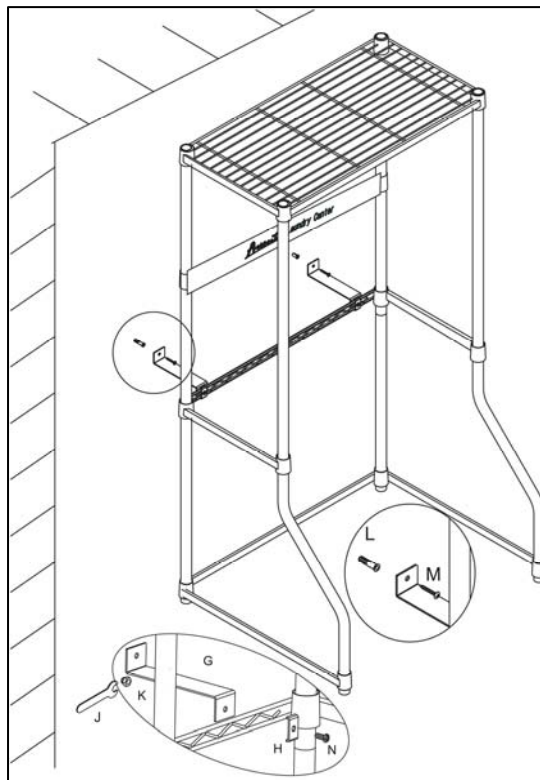

Step 6: Installing Your Avanti Dryer (Model D110) to the top shelf.

In order to place your Avanti Dryer (Model D110) on the stacking kit you must first remove the four (4) leveling legs from the bottom of the dryer.

- a) Place the Dryer on the top shelf.
- b) Re-install the four (4) leveling legs previously removed through the underside of the top shelf and tighten until the dryer is secure.

